

Precoat Locking Agent for Female Threads and Improved Precoat Sealing Agent for Male Threads

Introduction

Until now, Three Bond MEC was used only for precoating male threads i.e., bolts, screws. However, in many instances male threads cannot be precoated because it is a fixture of the assembled part. Therefore anaerobic sealing agents and mechanical locking parts (capsule nut, etc.) had to be used.

To solve this problem Three Bond has developed Three Bond 2481 "MEC for Female Threads". This process precoats female threads (i.e., nuts) with micro-encapsulants. The following describes Three

Bond 2481 in greater detail.

In addition, Three Bond 2353 "Precoat Sealing Agent for Male Threads" is also introduced below. It has greatly improved sealability and chemical resistance compared with conventional precoat sealing and locking agents (precoat sealing and locking agents for bolts, plugs, etc. are called Sealock).

* MEC is an abbreviation for Micro Encapsulation.

Contents

Introduction.....	1	4. Effects of temperature on locking strength	6
I. Three Bond 2481	2	5. Thermal deterioration test	6
A. Background of MEC for Female Treads ...	2	D. Conclusion	6
1. Types of locking agents	2	II. Three Bond 2553.....	7
2. Expected market share of chemical locking agents	2	A. Outline	7
3. What is MEC for Female Threads?	3	1. General properties and special characteristics.....	7
4. Origin of MEC for Female Threads	3	2. Performance comparison of TB2353 vs current products	7
B. Outline.....	3	3. Sealing function	7
1. General characteristics	4	B. Features	8
2. Setting mechanism	4	1. Storage stability	8
C. Features	5	2. Sealing test.....	8
1. Storage stability.....	5	C. Conclusion	9
2. Setting time	5	III. Three Bond's fastener processing system ..	10
3. Effects of fastener material on locking strength.....	5		

I. Three Bond 2481

A. Background of MEC for Female Threads

1. Types of Locking Agents

	Solvent locking agent	Anaerobic locking agent	Precoat locking agent
Features	Sets by organic solvent evaporation. Coats well, slow hardening, low strength, comparatively low viscosity, moderate cost, good shelf life.	Reacts and sets primarily upon removal of oxygen. Various strengths and hardening speeds available, satisfactory chemical resistance.	Breaking open the microcapsule allows the main agent to react with the hardener. Satisfactory operability during assembly. Sets even with ill fitting fasteners.
Applications	For sealing and bonding screws, fitted portions, bonded surfaces, etc. For fasteners of all pipe diameters. Locks small screws for electronic parts.	For sealing and bonding screws, fitted parts, bonded surface, etc. For locking bolts requiring comparatively higher strength.	Exclusively for screws. Has wide application range: from eyeglass screws to large diameter construction machinery bolts. Suitable for on-line assembly, For small diameter pipe fasteners in transportation components.
Product Name	TB1400 series	TB1300 series TB3000 series TB1110B	TB2400 series

2. Expected Market Share of Chemical Locking Agents

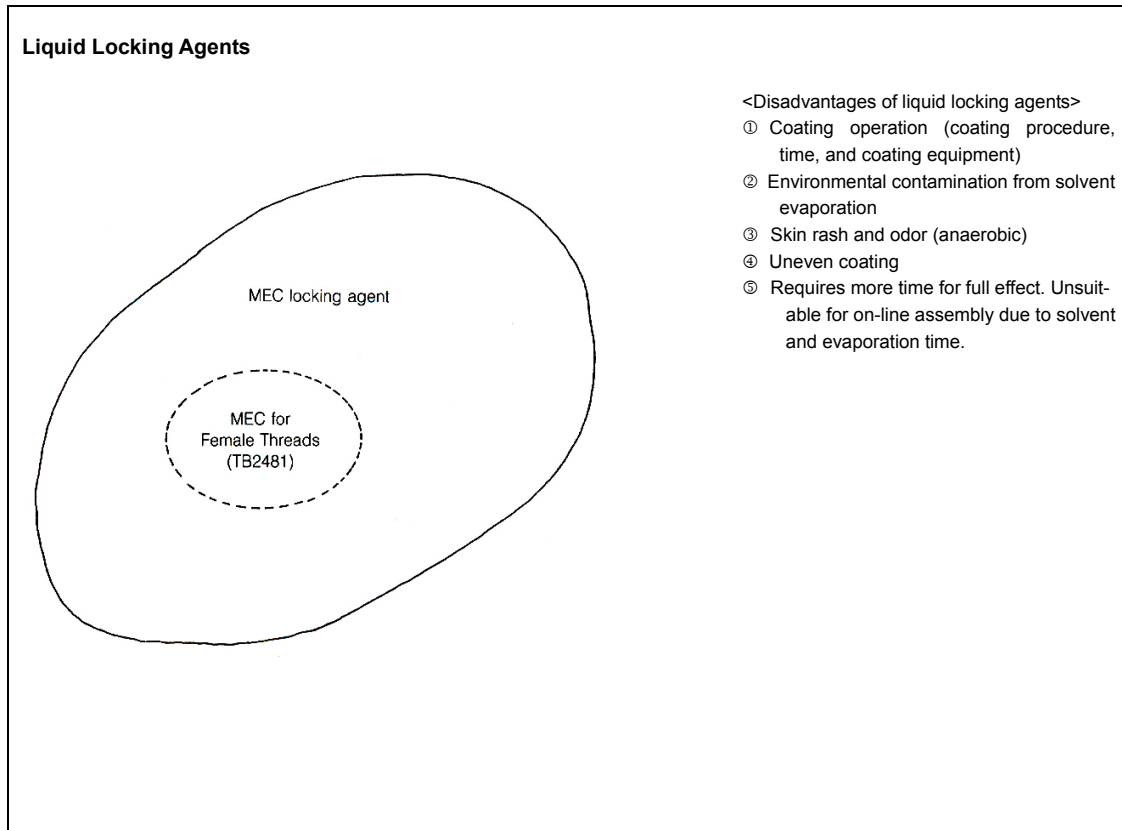

3. What is MEC for female Threads?

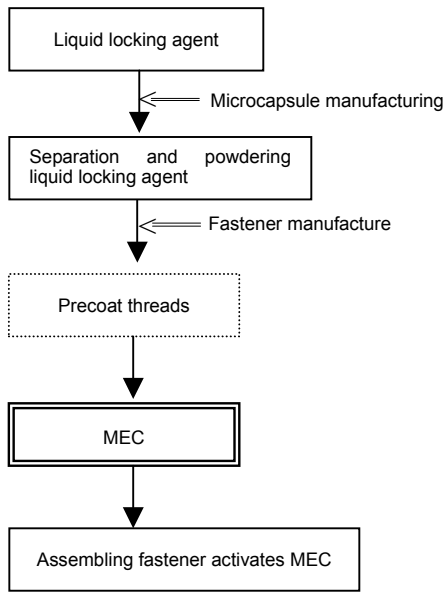

The female fastener itself performs a locking function by special application of micro-encapsulated, high reaction type locking agent to prevent loosening of various female fasteners.

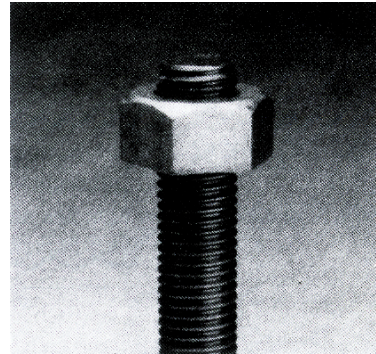

Three Bond has developed both male and female coating systems which has made great contributions to industries for threaded fastener locking.

4. Origin of MEC for Female Threads

Since inception, Three Bond's R&D motto is "To develop products which improve quality at the same time reduce cost". TB1400 series solvent based locking agents and TB1300 series anaerobic locking agent has won the confidence of our customers. However, the coating quality of these liquid locking agents are inferior so from a total cost viewpoint the demand for precoated fasteners has increased.

Furthermore, in recent years, weight reduction has been demanded by the transportation

industry to preserve natural resources and prevent environmental contamination. Locking fasteners has evolved from physical locking by split-pin, caulking plate, etc. towards chemical locking by anaerobic locking agent, MEC etc. Our R&D developed MEC for Female Threads by combining a successful processing technique and solving the problem of too many capsules rubbing off onto the male threads before reaching bonding surface caused by tight clearance.

B. Outline

Three Bond 2481 (hereafter abbreviated as TB2481) is coated to female threads with a microcapsule locking agent and has excellent bonding and chemical resistance just as with previous MEC products.

In the case of coating female threads, the quantity of microcapsules remaining on the

locking surface diminishes and seems to create a performance problem. But TB2481's locking strength equals the previous medium strength MEC for male fasteners, even for tight clearances.

Figure 1 shows the correlation between the projection rate*1 and locking strength of TB2481 compared to previous MEC products.

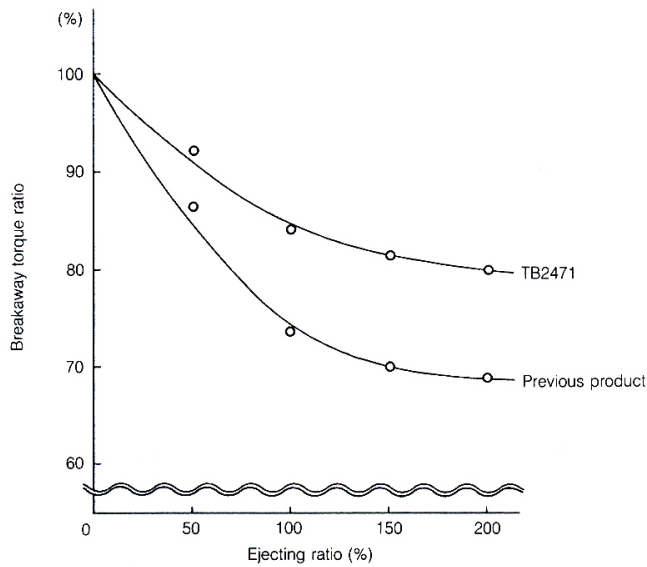
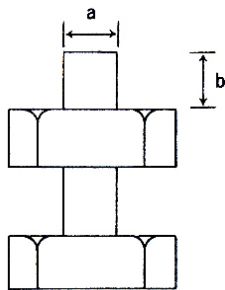

Figure 1

<Test Conditions>

·Tightening torque...29 N·m{300 kgf·cm}

*1·Projection rate... $S (\%) = b/a \times 100$



a: Bolt diameter
b: Protruding length from nut

1. General Characteristics

Appearance	Standard setting time	Locking strength ^{*2} N·m{kgf·cm}
Red	25°C for 48 hours	40{410}~ 60{610}

*2: JIS class 2, M10 × P1.5 untreated steel bolt and nut 29 N·m{300 kgf·cm}
Return torque after tightening and left standing for 48 hours at 25°C.

2. Setting Mechanism

The physical pressure exerted on the female threads during tightening breaks open the microcapsules and adhesives in the capsules oozes out. Then this adhesive sets quickly and demonstrates locking strength. (Figure 2)

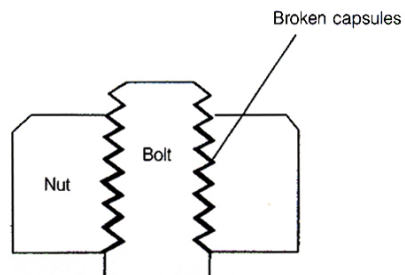

Figure 2

C. Features

1. Storage Stability

The female threads coated with TB2481 will maintain initial locking strength for about 6 months at room temperature.

Since the female threads are coated with MEC, the coated surface is rarely scared by impact during transportation, unlike male coated threads.

2. Setting Time

TB2481 applied to a M10 untreated steel bolt reaches full strength in about 48 hours after tightening at room temperature. (See Figure 3)

<Test Conditions>

- Tightening torque...29 N·m {300 kgf·cm}
- Ejecting ratio...50%
- Bolts and nuts used...JIS Class 2, M10×P1.5 untreated steel

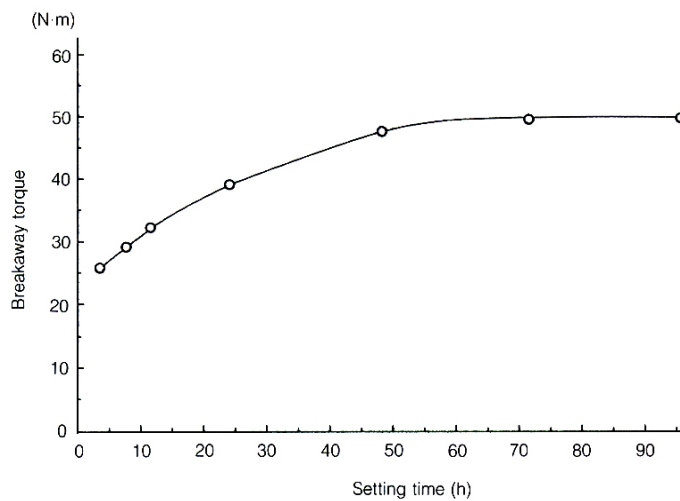

Figure 3

3. Locking Strength-Adherent Relationship

Fastener material for both male and female coated fasteners caused slight differences in locking strength, but test results show excellent locking strength for almost all types of fastener materials. (See Figure 4)

Tightening torque

▨ 0 N·m

▤ 29 N·m

Ejecting ratio...50%
Setting conditions...48 hours at 25°C
Bolt size...M10×P1.5

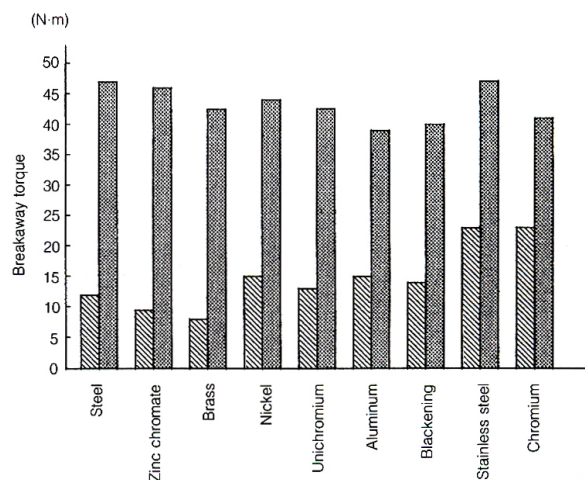

Figure 4

4. Locking Strength-Temperature Relationship

The locking strength of TB2481 deteriorates when heated but even at about 100°C, it has locking strength above the initial tightening torque (See Figure 5)

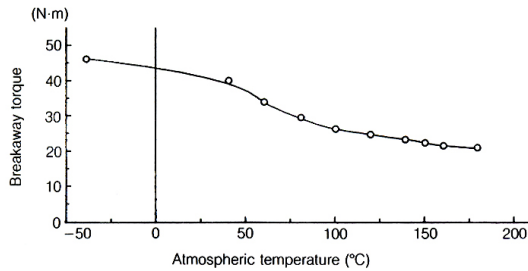

Figure 5

5. Thermal Deterioration Test

Even in the thermal deterioration test of 150°C for 240 hours, the locking strength rarely drops and stabilized locking strength can be obtained. (See Figure 6)

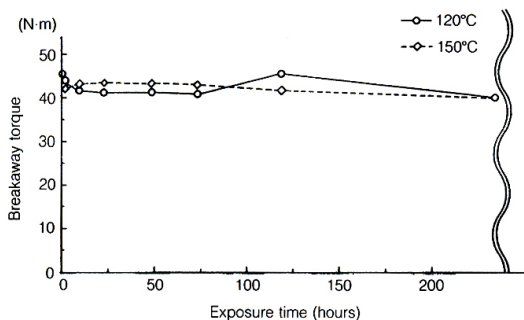

Figure 6

<Testing Conditions>

After tightening at 29 N·m, test pieces are left to set for 48 hours at 25°C. Then the test pieces are left to set at various temperatures for 2 hours each and the breakaway torque at various temperatures was measured.

- Ejecting ratio...50%
- Bolts and nuts used...JIS Class 2, M10×P1.5 zinc chromate

<Testing Conditions>

After tightening at 29 N·m, test pieces are set for 48 hours at 25°C. The fasteners are exposed to various temperatures for a prescribed time, then left standing until room temperature is reached. Then the breakaway torque is measured.

- Atmospheric temperatures...120°C and 150°C
- Bolts and nuts used...JIS Class 2, M10 × P1.5 zinc chromate
- Ejecting ratio...50%

D. Conclusion

To prevent loosening, various locking agents and mechanical parts are being used. In recent years, due to demand for lighter weight, higher assembly productivity and cost saving, the conventional mechanical locking method is being supplanted by precoating with chemical locking agents. Applications for this coating method will continue to grow.

II. Three Bond 2353

A. Outline

At present, the transportation industry requires better performance for heat resistance, lighter weight and long term durability, etc. To satisfy these demands, Three Bond 2353 (hereafter called, “TB2353”) has been developed.

TB2353 Sealock contains acryl resin and

fluorocarbon resin as main ingredients and has excellent sealability, heat resistance and chemical resistance. Another advantage is minimal gouging of the locking agent while tightening.

TB2353 seals pipes and plugs on oil, water and fuel lines of engines and transmissions.

1. General Properties and Special Characteristics

Appearance	Sealability (M10 bolt, Tightening torque: 29 N·m{300 kgf·cm})
White	At the time heating at 150°C: 78 Mpa{80 kgf/cm ² }or above

2. Performance Comparison Between TB2353 and Current Products

Product name	Color	Heat resistance temperature	Pencil hardness	Chemical resistance			Main ingredient	Main feature
				Water (95°C)	Engine oil (95°C)	ASTM No.2 oil (95°C)		
TB2310	Yellow	150°C	6B	5	4	4	Silicone	Excellent heat resistance; weak tightening resistance.
TB2302	Green	100°C	HB	5	5	5	Alkyd	For general use; excellent chemical resistance.
TB2306	Red	120°C	2H	5	5	5	Melamine	Excellent chemical resistance
TB2350	White	80°C	2B	4	4	5	Acrylic and fluorocarbon	Weak tightening and abrasion resistance
TB2350B	White	80°C	3B	4	4	5	Acrylic and fluorocarbon	Weak tightening and abrasion resistance
TB2353	White	150°C or above	6B or below	5	5	5	Acrylic and fluorocarbon	Excellent heat resistance; good sealability Excellent chemical resistance Weak tightening resistance; minimal gouging

Note: “5” is better than “4”

3. Sealing function

TB2353 has a soft coating film and expands widely during tightening (good malleability). Therefore, it fills small gaps and has high sealability even with ill fasteners.

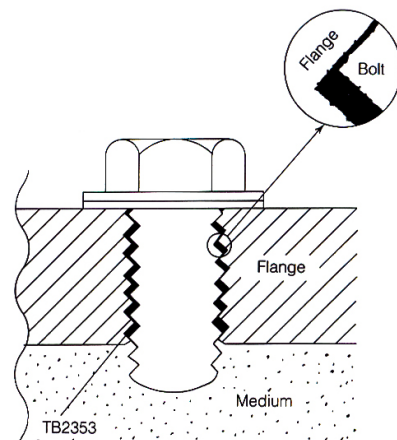

Figure 1

B. Outstanding Features

1. Storage Stability

TB2353 after coating onto fastener maintains initial strength for over six months when stored at room temperature.

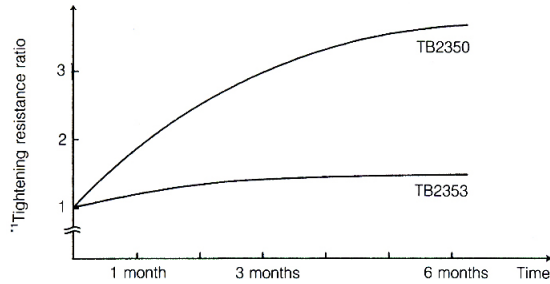

Figure 2

Figure 2 compares tightening resistance between bolts coated with TB2353 and with previous TB2350 Sealock.

*1 Tightening resistance ratio...Assumes fastener tightening resistance immediately after coating equals "1". Tightening resistance measured as storage time expired.

2. Sealing Functions

Comparison between TB2353 and current product

a) Sealability test at room temperature

Using testing machine shown in Figure 3 and 4, test pieces are pressurized to 2.0 MPa {20 kgf/cm²} and stored. Then the leakage condition was confirmed.

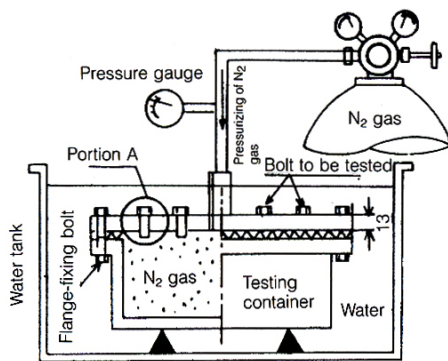

Figure 3 General View

JIS Class 2 untreated steel bolt and zinc chromate plated bolt

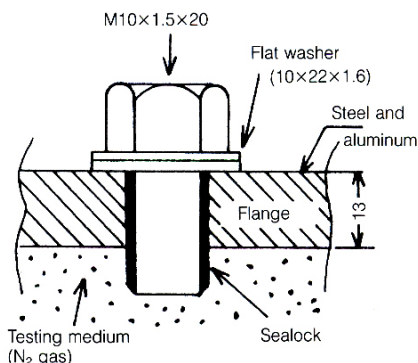

Figure 4 Detailed View of Portion A

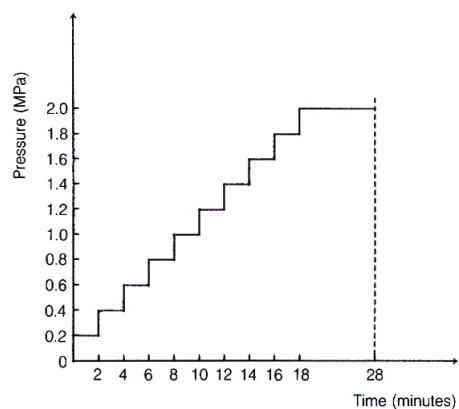

Figure 5

Tightening torque 29 N·m{300 kgf·cm}
 Flange Steel and aluminum
 Testing medium N₂ gas
 No. of test pieces n=10

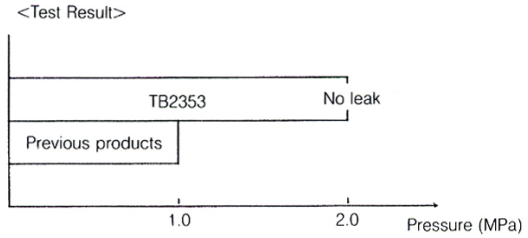

Figure 6

b) Heat sealability

Using testing machines shown in Figures 7 and 8 and the testing methods shown in A, test pieces have been pressurized up to 7.8 MPa {80 kgf/cm²} at 150°C. The leakage condition at the prescribed time is confirmed.

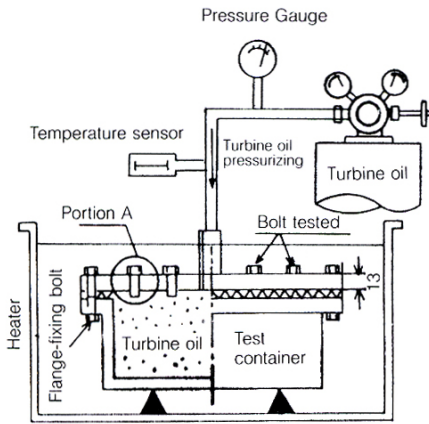

Figure 7 General view

JIS Class 2 untreated steel bolt and zinc-chromate plated bolt

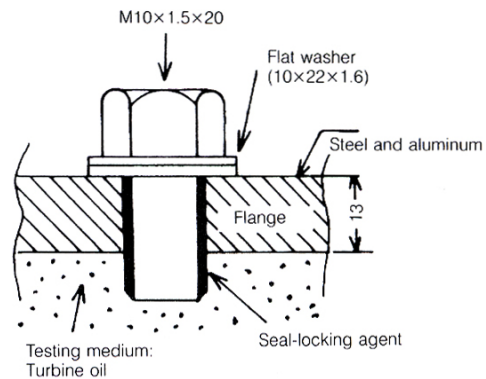

Figure 8 Detailed View of Portion A

Tightening torque 29 N·m{300 kgf·cm}
 Flange Steel and aluminum
 Testing medium N₂ gas
 No. of test pieces n=10
 Testing temperature 150°C

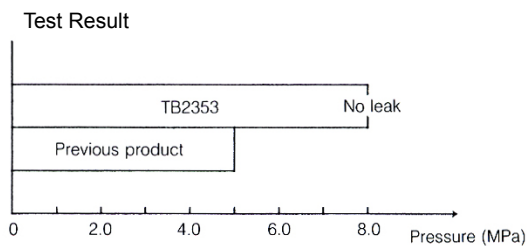

Figure 9

Note: These test results do not represent product rating. Before using, test the part under actual conditions.

C. Conclusion

For many years Three Bond has been developing Sealock which is resin applied in a special way to seal threads. Three Bond perfected this product and it has been satisfying the needs of our customers.

TB2353 is a product developed for meeting increasing performance requirements. Three Bond strives to save energy, reduce weight and save cost.

III. Three Bond's Fastener Processing System

The customer or his supplier delivers the fasteners to be coated to a Three Bond MEC coating plant. Then the processed fastener will

be delivered either directly to the customer or through the fastener manufacturer.

