

# ThreeBond TECHNICAL NEWS

Three Bond Technical News  
Issued July 1, 2009

74

## UV-Curing Sheet Adhesives

### Introduction

---

From its very beginnings, ThreeBond has continued to develop a wide range of liquid adhesives that have won wide commercial acceptance.

In recent years, we have also sought to develop an adhesive based on an entirely new concept, drawing on liquid adhesive technologies accumulated through many years of experience. The new product is a functional sheet-form adhesive that combines the advantages of sheet-type adhesives (e.g., double-sided adhesive tape) and our liquid adhesives.

This issue introduces the ThreeBond 1630 UV-curing sheet adhesive, one of the functional sheet adhesives currently being developed at ThreeBond, to which we have added ultraviolet curing properties.

### Contents

Introduction.....	1	3-4. Reliability data .....	4
1. Background .....	2	4. Using ThreeBond 1630 .....	5
2. What is a UV-curing sheet adhesive? .....	2	4-1. Steps in bonding with ThreeBond 1630.....	5
3. ThreeBond 1630 UV-curing sheet adhesive.....	2	4-2. Recommended bonding machines.....	5
3-1. Features.....	2	5. Examples of applications .....	6
3-2. Properties .....	3	6. Examples of advanced applications.....	7
3-3. Characteristic values .....	3	Conclusion .....	8

## 1. Background

Recent rapid progress in flat-panel technologies for display devices, including LCD displays, had led to the creation and practical application of various new techniques, including the use of adhesives to bond optical components—LCD panels, touch panels, and panel overlays—to produce flatter display devices and to improve display qualities or to increase the shock resistance of the display devices.

Such applications demand the following functions and characteristics from adhesives:

- Increased visibility
- Characteristics that help improve device stiffness
- Conformability to surface geometry, such as uneven surfaces caused by printed ink
- High reliability (thermal, humidity, and weathering resistance)

The conventionally preferred bonding agents for such applications have been liquid UV-curing resins and/or double-sided adhesive tapes designed for optical applications. However, the former class of materials is associated with various problems, including bubble inclusion, squeeze-outs from component edges, and irregular thicknesses. While offering excellent uniformity in thickness among optical double-sided tapes, the latter class of materials cannot be made to conform to the undulations created by printed ink and also pose reliability issues.

In response, ThreeBond developed the ThreeBond 1630 UV-curing sheet adhesive. This product resolves the problems associated with conventional liquid UV-curing resins and optical double-sided adhesive tape: It is free of bubble inclusions and squeeze outs, has uniform thickness, and conforms to adherend geometries. (ThreeBond will be abbreviated “TB” hereafter.)

## 2. What is a UV-curing sheet adhesive?

A UV-curing sheet adhesive is a solid sheet at room temperature but can be fluidized by the application of pressure or heat, then cured completely within seconds when irradiated with UV light.

Since the adhesive is a solid sheet at room temperature, it offers highly uniform thickness and easy handling, much like double-sided adhesive tape. In addition, its fluid properties under pressure or heat allows it to conform, like liquid adhesives, to the surface geometry of the adherend. The end result is a unique adhesive that combines the advantages of double-sided adhesive tape and liquid adhesive.

Table 1 and Figures 1 to 3 present the features of TB1630 UV-curing sheet adhesive, liquid UV-curing resin, and optical double-sided adhesive tape.

Table 1. Comparison of features of various adhesives

	TB1630	Liquid UV-curing resin	Optical double-sided adhesive tape
Transparency	○	○	○
Uniformity of layer thickness	○	×	○
Susceptibility to squeeze-outs	○	×	○
Conformability to surface geometries	○	○	×
Reliability	○	○	×

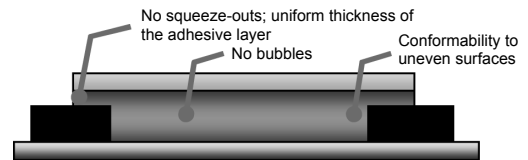

Figure 1. TB1630

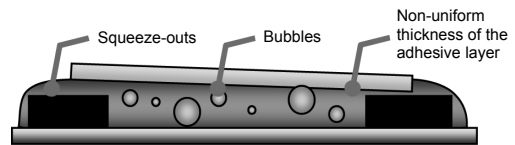

Figure 2. Liquid UV-curing resin

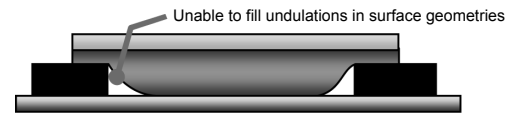

Figure 3. Optical double-sided adhesive tape

## 3. ThreeBond 1630 UV-curing sheet adhesive

### 3-1. Features

TB1630 is a UV-curing sheet adhesive.

The key features of TB1630 are given below.

Features:

1. High transparency for enhanced visibility in applications requiring use of adhesives in the light path.
2. Its sheet form allows large surface areas to be bonded together while ensuring uniform adhesive thickness between surfaces.
3. TB1630 is fluidized by the application of heat/pressure to allow conformance to the surface geometry of the adherend.
4. The flexible cured resin is highly resistant to both shock and vibration.
5. As a reaction adhesive, TB1630 displays high resistance to temperature, humidity, and weathering stress factors.

### 3-2. Properties

Table 2 presents the properties of TB1630. Fig. 4 illustrates the product structure.

Table 2. Properties of TB1630

	Unit	TB1630	Test method	Notes
Appearance	–	Colorless, transparent	3TS-201-1	
Adhesive layer thickness	μm	30	3TS-261-01	
Flow initiation temperature	°C	65	3TS-209-01	Rheometer tan δ=1
Loss on heating	%	3.0 or less	3TS-216-1	120°C × 30 min

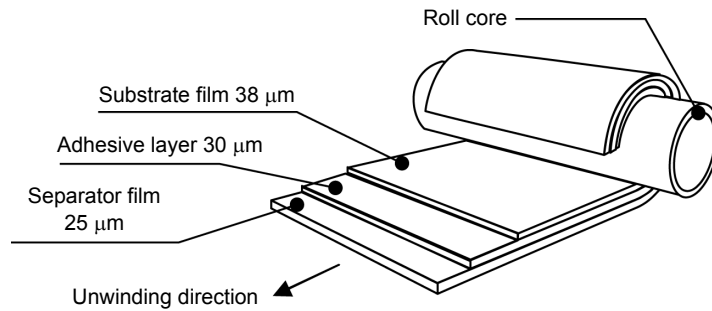

Figure 4. Product structure

### 3-3. Characteristic values

Table 3 presents the characteristic values of TB1630.

TB1630 is designed to have nearly the same refractive index as glass. It provides high

transmission in the visible light range—99% or better—when used on glass adherends. This makes it ideal for optical assembly applications.

Table 3. Characteristic values of TB1630

Tested items		Unit	TB1630	Test method	Notes
Refractive index		–	1.51	3TS-536-01	
Tensile shear strength	glass/glass	MPa	5.1	3TS-301-11	
	acrylic/glass		4.0		
	polycarbonate/glass		3.5		
Elastic modulus (25°C)		Pa	$1.9 \times 10^6$	3TS-501-04	DMA loading in tensile mode (1 Hz)
Visible light transmission		%	99.94 to 99.74	500 to 800 nm UV/Vis spectrophotometer	glass/TB1630/glass sandwich structure Reference: glass (1 sheet)

Curing condition: Integral radiation of 30 kJ/m<sup>2</sup> (measured at 365 nm wavelength)

### 3-4. Reliability data

Figures 5 to 8 present the results of reliability testing.

We confirmed high reliability with respect to adhesive strength in both high-temperature and

high-temperature and high-humidity tests. Spectral transmittance remained virtually unchanged, even after 1,000 hours of simulated weathering as logged on a weather meter. These results point to remarkable resistance to environmental factors.

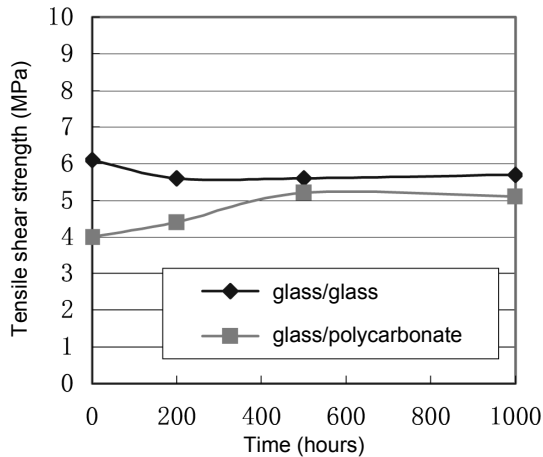

Figure 5. Change in tensile shear strength when subjected to conditions of 60°C x 95% RH

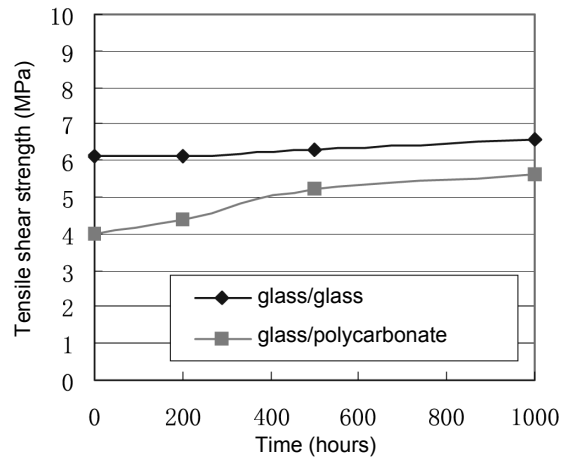

Figure 6. Change in tensile shear strength when subjected to conditions of 85°C x 85% RH

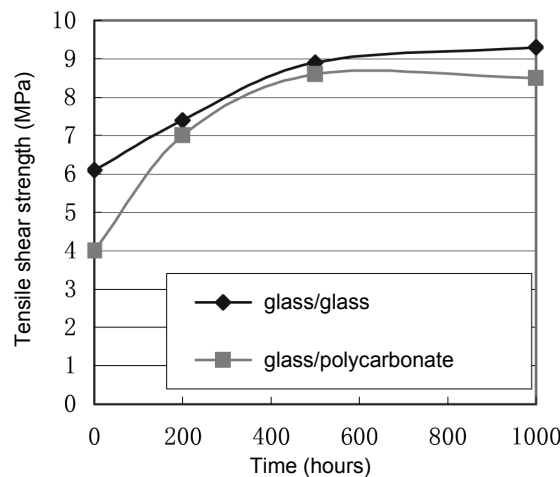

Figure 7. Change in tensile shear strength when subjected to temperature of 100°C

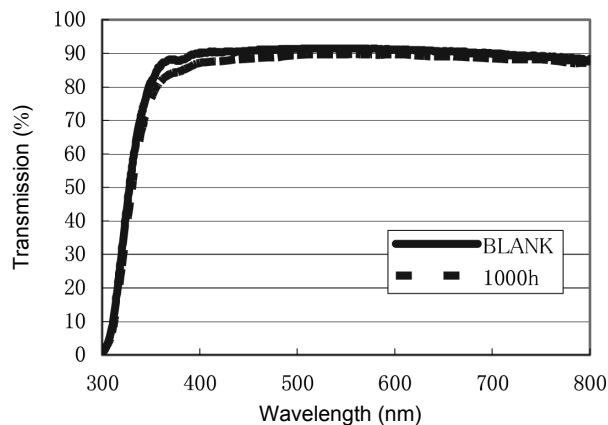

Figure 8. Change in spectral transmittance when subjected to simulated weathering (no reference)

#### 4. Using ThreeBond 1630

##### 4-1. Steps in bonding with ThreeBond 1630

The three main steps in bonding with the TB1630 consist of the transfer, bonding, and curing processes. Figure 9 presents the steps that make up the bonding process.

##### 1. Transfer process [Figure 9, (1), (2), & (3)]

The transfer process for TB1630 involves the following two steps: in step (1) peel off the separator film on the light-peeling side. In step (2) use a roll laminator to apply heat and pressure to increase contact between the sheet adhesive and the adherend and to ensure a secure transfer.

##### 2. Bonding process [Figure 9, (4) & (5)]

After the transfer is successfully completed, in step (4) peel off the remaining substrate film on the reverse side of TB1630 and press onto the other adherend. In step (5), the adherends placed in contact are pressed together under heat to create the bond. Ideally, this step should be performed in a vacuum to ensure a bubble-free adhesive layer.

Recommended adhesion devices include a vacuum press and vacuum laminator. These will be discussed further below.

##### 3. Curing process [Figure 9, (6)]

Cure TB1630 by irradiating with UV light. The curing conditions is  $30 \text{ kJ/m}^2$  (measured at 365 nm).

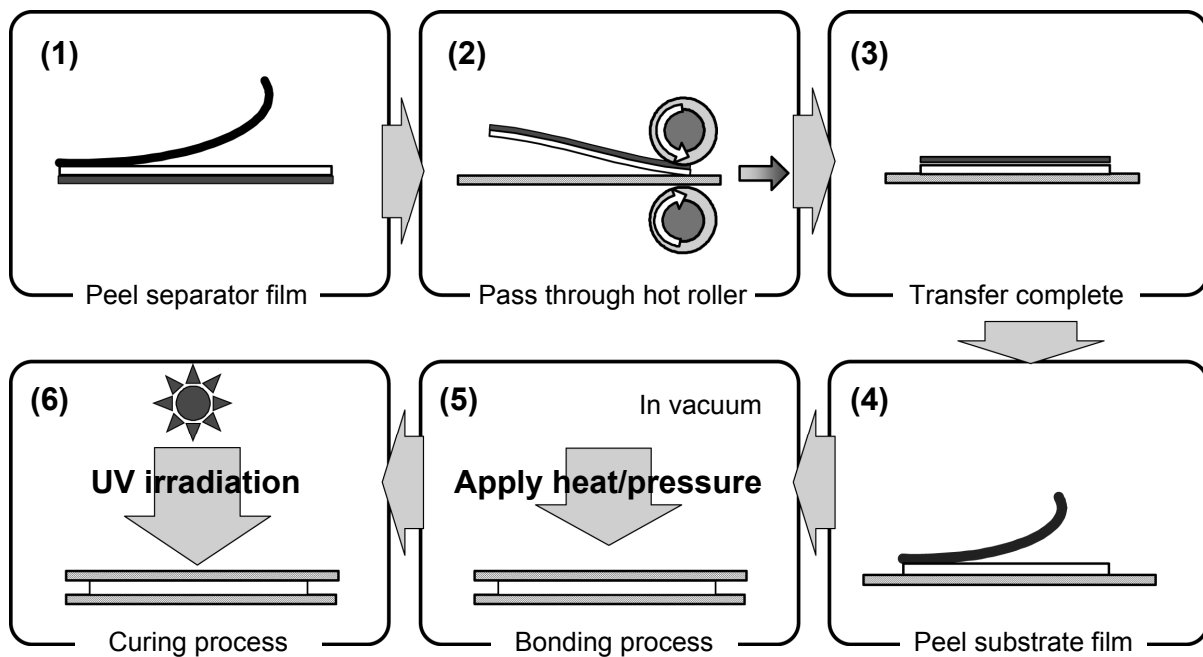

Figure 9. Step-by-step bonding with the TB1630

##### 4-2. Recommended bonding machines

We recommend the following equipment for the above processes:

##### 1. Roll laminator

This device performs pressure-bonding by passing the adherend elements through rotating rubber rollers.

Ideal for pressure-bonding films and thin flat plates, the roll laminator is used to transfer TB1630 to the adherend and to bond films. The process can

be performed continuously from roll to roll to enhance productivity.

We recommend using heat roll laminators to maximize contact between the adhesive and adherend.

Figure 10 presents a schematic diagram of a roll laminator unit.

## 2. Vacuum press

The vacuum press laminator applies heat and pressure in a vacuum via an air cylinder. Figure 11 presents a schematic diagram of a vacuum press unit.

The vacuum press unit enables high-pressure pressing under vacuum conditions. It is ideal for applications such as bonding two highly parallel rigid bodies or bonding films onto surfaces.

## 3. Diaphragm vacuum laminator

The vacuum laminator consists of two chambers, an upper chamber and a lower chamber, separated by a rubber diaphragm. Both chambers are evacuated. Air is then allowed to flow into the upper chamber. The pressure difference created between the chambers inflates the rubber diaphragm, which presses the elements to be laminated against each other. Figure 12 illustrates the vacuum laminator mechanism. A hot plate is placed in the lower chamber, which makes it possible to apply both heat and pressure simultaneously.

Since the vacuum laminator uses a rubber diaphragm for pressing, the diaphragm conforms to the surface geometry of the work element and applies pressure evenly over the entire surface. The rubber diaphragm allows effective pressure application even at low pressures, making the device ideal for bonding delicate elements. Figure 13 is a photo of a vacuum laminator unit.

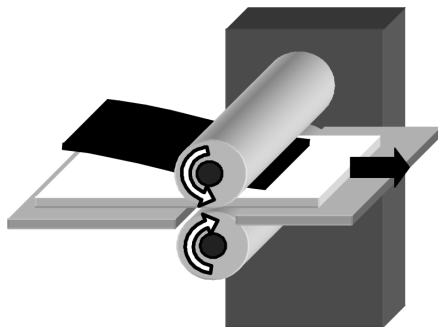

Figure 10. Roll laminator

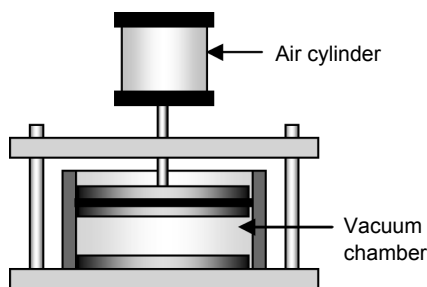

Figure 11. Vacuum press

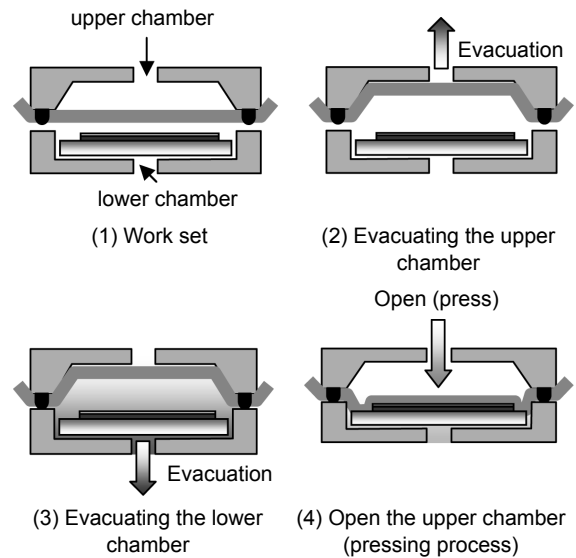

Figure 12. Vacuum laminator operating mechanism

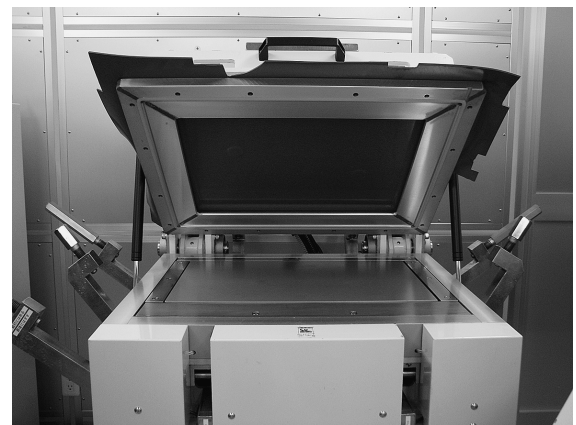

Figure 13. Vacuum laminator

## 5. Examples of applications

In addition to enhanced visibility, TB1630 produces an adhesive layer free of air bubbles and squeeze-outs with high conformity to irregularities in the adherend surface—characteristics beyond the reach of conventional liquid UV-curing resins or optical double-sided adhesive tapes when either class of products is used alone.

TB1630 is ideal for areal adhesion onto display modules that require highly transparent display surfaces for visibility.

[Main applications]

- (1) Bonding of panel overlays\* to LCD modules
- (2) Bonding of touch panels to LCD modules
- (3) Bonding of panel overlays to touch panels
- (4) Bonding glass/glass surfaces
- (5) Bonding optical films
- (6) Other optical assembly applications

\* Panel overlays are protective panels for displays such as LCDs (as shown in Figure 14), typically composed of materials such as glass or plastic (acrylic resins, polycarbonates, etc.).

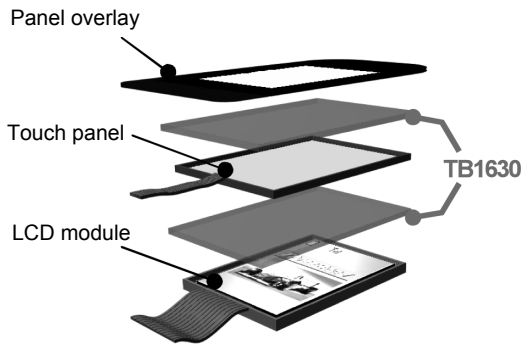

Figure 14. Example of applications: LCD module/touch panel and touch panel/panel overlay

## 6. Examples of advanced applications

### Bonding materials with different thermal expansion coefficients

In recent years, manufacturers have begun exploring switching from glass to plastics to make cell phone panel overlays. Candidate materials include acrylic resins or polycarbonates. However, such changes pose certain technical issues.

- Heating generates gas from the plastic and creates bubbles, creating cosmetic defects.
- The difference in coefficients of thermal expansion between the glass LCD module and the plastic panel overlay generates distortion when heat is applied, creating display problems. Additionally, warping of the plastic material can cause the panel overlay to peel off.

We propose the following procedure to resolve these technical issues. Figure 15 presents a flow chart for the recommended procedure.

#### 1. Preparatory process

The air bubbles produced when bonding plastics is due to the gases present in the plastic material. The plastic material to be used must be baked (heated) before processing to degas the material and suppress bubble generation during bonding.

#### 2. Transfer process

Perform the standard transfer process.

#### 3. Bonding process

When heat is applied during the bonding process, the difference in thermal expansion coefficients between the materials generates distortions in the materials. Pressing adherend elements when they are distorted increases the likelihood of display problems.

To avoid this, bonding should be performed in a vacuum at normal temperatures. Bonding at normal temperatures will reduce distortion caused by differences in thermal expansion characteristics.

#### 4. Post-process

Bonding at normal temperatures will produce inadequate adhesion to the adherend. The adherend elements must be subjected to a thermal treatment (aging) after bonding to achieve the necessary degree of wetness.

The yield rate of the manufacturing process can be improved by removing the small amounts of air bubbles remaining by applying heat and pressure in an autoclave.

Applying these steps when necessary on a case by case basis should eliminate air bubbles and display problems when bonding plastic panel overlays to LCD modules using TB1630

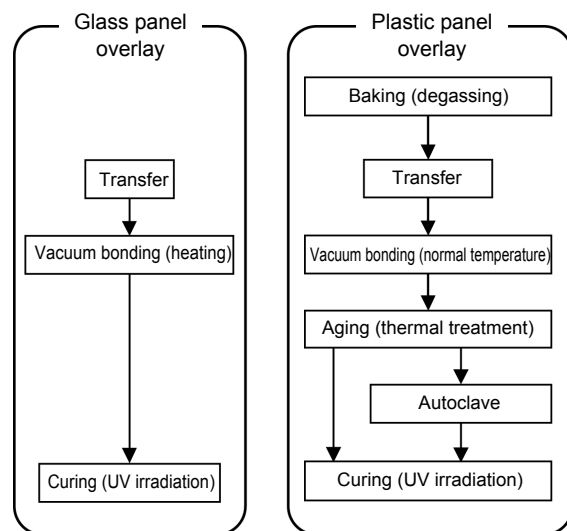

Figure 15. Flowchart of the bonding process

## Conclusion

Functional sheet adhesives are revolutionary adhesives that combine the advantages of liquid UV-curing resins and optical double-sided adhesive tapes. ThreeBond is currently developing a full range of sheet adhesive products in addition to the UV-curing sheet adhesive introduced in this issue, including heat-cured products and products offering other functions.

We intend to continue in our efforts to develop sheet adhesives offering new functions to provide customers with an ever broadening lineup of products.

Takashi Nemoto  
Yoshiaki Koga  
Functional Material Development Department  
Product Development Division  
R&D Group  
ThreeBond Co., Ltd.

